

M12 male receptacle A-cod. FM F&B Pro

wires PP 5x0.34 0,2m

F&B Pro

Flange male

M12, 5-pole

Front mounting

Stainless steel 1.4404 (V4A)

IP69K

Further cable lengths on request.

[Link to Product](#)

Illustration

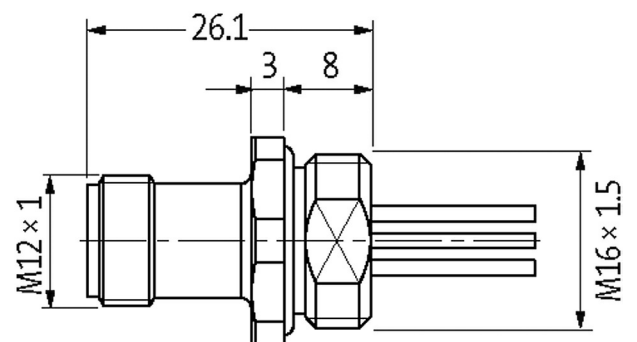

Male

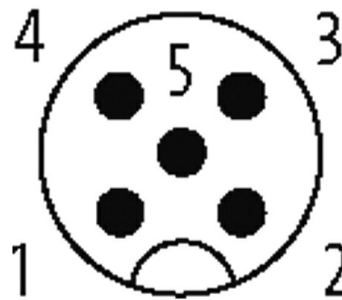

Product may differ from Image

Approvals

Form

Form 13521

General data

Pollution Degree 3

Temperature range -40...+105 °C, depending on cable quality

Cables

Cable number	975
No./diameter of wires	5 × 0.34 mm ²
Wire isolation	PUR (br, wh, bl, bk, gnye)
Outer Ø	1.3 mm ±5%
Temperature range (fixed)	-40...+90 °C
Temperature range (mobile)	-25...+90 °C
Material (wire)	Cu wire, tin plated
Resistor (core)	max. 58 Ω/km (20 °C)
Nominal voltage	300 V AC
Test voltage	1500 V AC
Bend radius (fixed)	5 × outer Ø

Technical Data

Operating voltage	max. 125 V AC/DC
Rated surge voltage	1.5 kV
Operating current per contact	max. 4 A
No. of poles	5
Material group	IEC 60664-1, category I
Coding	A-coded
LED display	no
Locking of ports	Screw thread (M12×1 mm) recommended torque 0.6 Nm, self-securing
Compression gland	M12 (SW14)
Protection	IP67, IP69K mounted and tightened
Locking material	Stainless steel 1.4404 (V4A)

Commercial data

country of origin	DE
customs tariff number	85444290
EAN	4048879759434
eClass	27279218
Packaging unit	1

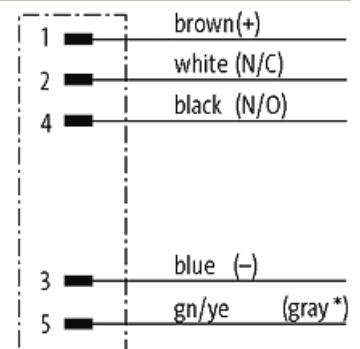
Sketch

(* for cable type 902 and 972)

Product may differ from Image